

INSTRUCTION MANUAL

PRIMUS ML 2.0

Lightweight wheelchair



Preliminary Note

Dear user,

Thank you for choosing a PRIMUS ML 2.0 wheelchair from Besco Medical!

You now have a modern aid to support you in your everyday life.

We have paid attention to functionality and quality when manufacturing this wheelchair.

Your new wheelchair has numerous adjustment options and can be adapted to your needs.

Please read this instruction manual carefully before using the wheelchair for the first time in order to familiarise yourself with the adjustment options. The instruction manual also contains valuable tips and important safety instructions for the correct use and care of the wheelchair.

Please store this instruction manual carefully so that you can make notes and look up functions while using the wheelchair too.

If you have any questions or need additional information, please contact the dealer who supplied you with the wheelchair, who will be happy to advise you.

Your wheelchair is delivered from the factory fully assembled and packaged in a cardboard box. Please keep the packaging if possible. It can be used to store the wheelchair at a later date if necessary.

Before using for the first time, you simply need to unfold the wheelchair and hook in the leg supports. In the following chapters, you will find instructions on how to make the wheelchair ready for use and how to use it. But first, here are the safety instructions.

CONTENTS

1	General information	4
2	Signs and symbols.....	5
3	Intended use	6
4	Indications.....	6
5	Contraindications.....	6
6	Delivery contents	6
7	Getting to know your wheelchair	7
8	Safety information.....	8
9	Putting the wheelchair into operation.....	13
9.1	Unfolding	13
9.2	Inserting the footrests	14
9.3	Adjusting the lower leg length	14
9.4	Adjusting the brakes	14
10	Additional setting options.....	15
10.1	Assembling and disassembling the rear wheels	15
10.2	Adjusting the height of the rear wheels	16
10.3	Adjusting the height of the front wheels	17
10.4	Adjusting the knee lever brakes	18
10.5	Adjusting the drum brake (depending on model)	19
10.6	Swinging away and disassembling the footrests	19
10.7	Foot board (fold-up)	20
10.8	Folding up the side panels	21
11	Using the wheelchair.....	21
11.1	Getting into the wheelchair from the side	21
11.2	Getting into the wheelchair from the front	22
11.3	Seat in the vehicle for transporting disabled people	23
12	Travelling in the wheelchair	26
12.1	General information	26
12.2	Push handles	27
12.3	Braking	27
13	Declaration of conformity.....	28
13.1	Labelling	28
14	Accessories and attachments.....	29
14.1	Tilting aid	29

14.2	Anti-tip wheels (optional).....	29
14.3	Seat belt (optional).....	29
14.4	Drum brake (depending on model).....	30
15	Care instructions.....	31
15.1	Cleaning.....	31
15.2	Disinfection.....	31
16	Storage and transport.....	32
16.1	General information.....	32
16.2	Storage conditions:.....	32
17	Disposal.....	33
18	Passing on the wheelchair.....	33
19	Technical data.....	33
20	Inspection and maintenance.....	35
20.1	Regular maintenance.....	36
21	Warranty and guarantee.....	38
	Notizen.....	39













1 GENERAL INFORMATION

This instruction manual is intended to help the wheelchair occupant and a carer to become more familiar with the operation and handling of the wheelchair. The manual is an integral and necessary part of the wheelchair. Keep the instruction manual handy and include it if you pass on the wheelchair to another owner. In this instruction manual, the generic masculine is used for better readability. Female and other gender identities are explicitly included. Please read the instruction manual in full before using the wheelchair for the first time. The wheelchair is designed for a maximum load of 130 kg.

Please note that despite careful review, it is possible that this instruction manual may contain incorrect information. Therefore, please visit our website regularly and check to see whether there is a recent version.

2 SIGNS AND SYMBOLS

To provide a quick overview of the contents of this instruction manual, we use the following symbols:

	Serial number	Enables the assignment of the medical device to a production batch
	Manufacturer	Indicates the manufacturer of the medical device
	Date of manufacture	Time of manufacture
	Observe instruction manual	The instruction manual must be read in full by the user before use.
	CE marking	Declaration of conformity, device complies with the European Medical Device Regulation MDR 2017/745
	Safety information	Safety information refers to risks that can lead to hazards and injuries. Safety information must be observed without fail.
	Labelling	Medical device
	Important information	Tips and suggestions that can facilitate the use of the product.
	Labelling	Attachment point for force nodes when used in a vehicle for transporting disabled people.
	Labelling	Label for marking products suitable for indoor and outdoor use
	Labelling	Label for marking products that must be protected from direct sunlight and rain
	Labelling	Label for indicating the maximum user weight
	Labelling	Label for specifying the seat width and overall height of the product

3 INTENDED USE

The wheelchair is designed for indoor and outdoor use. It is intended exclusively for the transport of a person sitting on the seat, either independently or with the assistance of a third party.

4 INDICATIONS

This aid is intended to support people who are unable to walk or who have severely impaired mobility as a result of

- Paralysis
- Loss of a limb
- Limb defect/deformation
- Joint contractures/joint damage (not on both arms)
- Other diseases

5 CONTRAINDICATIONS

This aid must not be used for

- Perception disorders
- Severe balance disorders
- Loss of both arms
- Joint contractures/joint damage in both arms
- Inability to sit
- Reduced or insufficient vision

6 DELIVERY CONTENTS

After receipt of the goods, please immediately check the delivery in order to verify that the contents are complete and intact. The content consists of:

- Outer packaging
- Wheelchair (pre-assembled)
- Pair of leg supports
- Operating instructions
- Service booklet

7 GETTING TO KNOW YOUR WHEELCHAIR

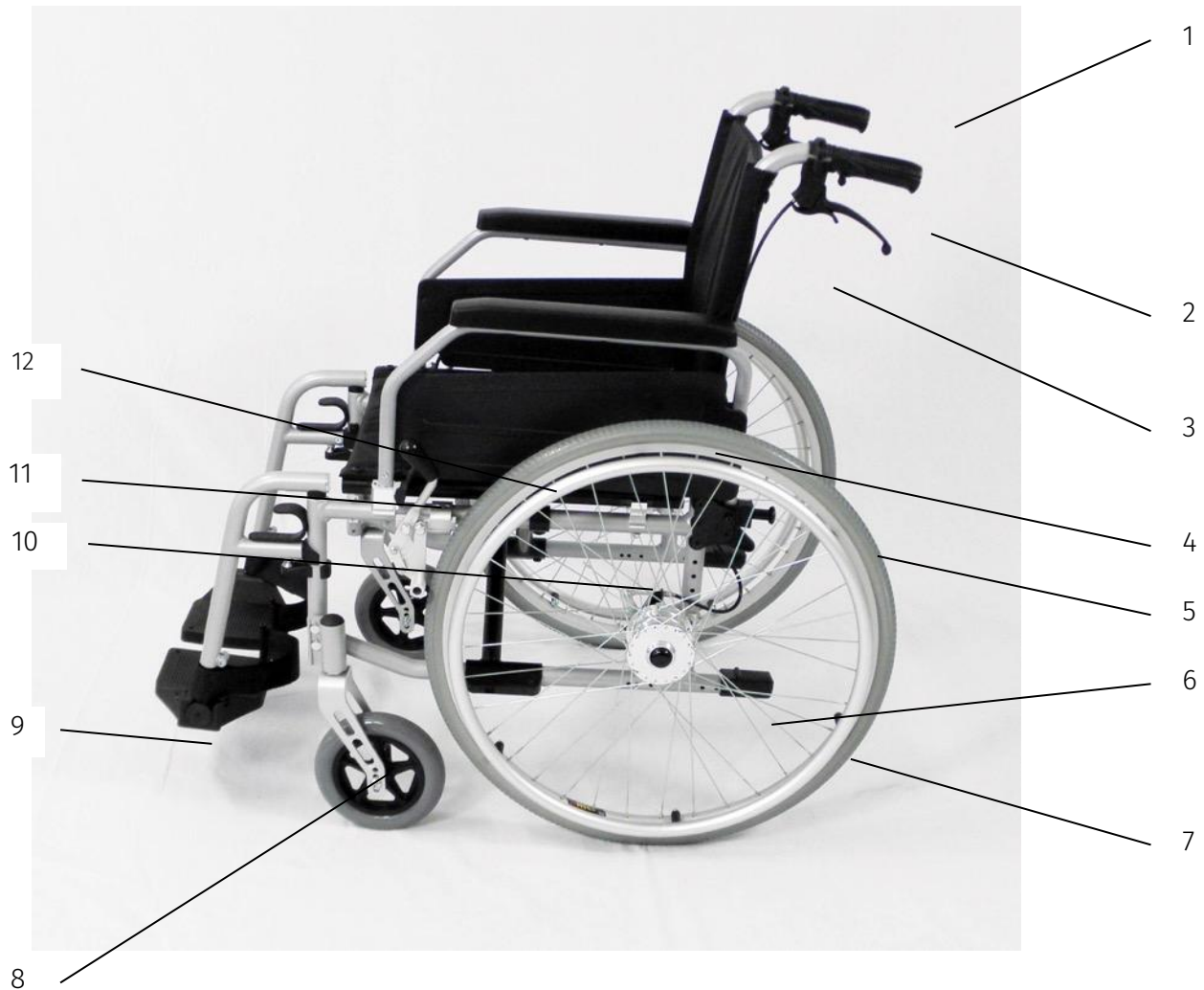

- 1 Push handles
- 2 Lever for drum brake
- 3 Back cushion
- 4 Side panel with armrest (padded, fold-away, removable)
- 5 Push rims (aluminium)
- 6 Drive wheel
- 7 Tilting aid
- 8 Steering wheels
- 9 Foot plates (fold-up)
- 10 Parking brake
- 11 Footrest, fold-up and removable
- 12 Seat

8 SAFETY INFORMATION

Flawless condition

 Before each use of the wheelchair, please check that all attached parts are properly attached and that the wheelchair as a whole looks functionally safe. Do not use the wheelchair if you have any doubts about its fitness for use.

Please check the wheelchair for obvious defects and wear and tear before each use. If you notice a defect or excessive wear, the wheelchair must no longer be used, as a safety risk may arise. In this case, the wheelchair must be repaired by a qualified specialist dealer.

Handling practice

 To avoid falls and dangerous situations, you should first practise using your new wheelchair on level, manageable terrain. It is recommended that you are assisted by an accompanying person in this case. Thoroughly familiarise yourself with the braking and acceleration behaviour when travelling straight ahead and round corners. Only use the wheelchair when you feel confident in doing so.

Intended use

 The intended use is described in the intended purpose. Any other use is at the sole risk of the user.

Never use the wheelchair under the influence of alcohol or other substances that affect attention or physical and mental perception and reaction.

Danger of burns or frostbite

 Please note that the upholstered parts and metal parts that are exposed to direct sunlight may heat up and cause skin injuries if touched. Therefore, make sure to cover these parts or protect the wheelchair from sunlight.

You should also avoid exposing the wheelchair to frost for long periods of time. In particular, metal parts that have cooled down considerably may cause injuries if they come into contact with the skin.

Children and young people

 Children and young people must never be left unattended in wheelchairs.

Dimensions

 The dimensions of the wheelchair exceed the recommended values of DIN EN 12183:2014/A.1 and PRM TSI Annex M for dimensions and manoeuvring range.

Risk of injury

 Your wheelchair consists of mechanical parts that move when settings are being adjusted or when the wheelchair is in use. Always handle the wheelchair with care in order to avoid injury from moving parts. For example, there is a risk of jamming when unfolding the wheelchair.

Armrests and footrests

 Before each use, make sure that the armrests and footrests are properly secured.

Transporting the wheelchair

 Never lift an occupied wheelchair by the armrests, as this could cause injury to the user and damage to the frame of the wheelchair. If the wheelchair needs to be lifted, this is only permitted if it is not occupied.

Getting in and out of the wheelchair

 Never stand on the footrests when getting in and out of the wheelchair. There is a danger of tipping over!

Brakes

 The brakes acting directly on the tyres of the wheels must only be used as parking brakes, i.e. they must only be applied when the wheelchair is at a standstill, and not to reduce the driving speed. Always lock both brakes before sitting in or getting up from the wheelchair.

Tyres

 To ensure the safe use of the wheelchair, the tyre tread surface must be free from damage. The tyres are solid rubber tyres and must be replaced if damaged.

Obstacles

 To overcome obstacles (e.g. kerbs, steps, etc.), please be sure to use ramps or obtain the assistance of a third party. Avoid driving into an obstacle without braking or driving down high ledges.

Uphill and downhill gradients, risk of tipping over

 Please note that the risk of tipping over may increase when the weight is shifted due to body movements or when the wheelchair is loaded. The same applies to uphill and downhill gradients of more than 10°.

Anti-tip supports can be fitted for increased protection against tipping backwards.

Only drive on uphill and downhill gradients of more than 10° with the assistance of a third party, otherwise the wheelchair will gain speed in an uncontrolled manner and it will no longer be possible to slow down.

Using the adjustment options

 The wheelchair settings should always be chosen such that the wheelchair user can counteract the risk of tipping over by shifting their upper body. If necessary, opt for settings with a low centre of gravity or move the rear axle backwards if possible. The installation of anti-tip supports can reduce the risk of tipping.

Surface condition

 It is not recommended to use the wheelchair on muddy or sandy surfaces due to the risk of getting stuck.

 Take extra care when driving on wet or icy surfaces, as there is an increased risk of slipping.

You should always cross ruts, rails or similar obstacles at a right angle (90°) if you cannot avoid them.

Stairs

 Stairs must only be climbed with the assistance of a third party. Any existing ramps or lifts must be used. In the absence of such facilities, the obstacle should be overcome by having two assisting people carry the wheelchair up the stairs.

Make sure that the assisting persons only touch the wheelchair at permanently mounted components (see Fig. 1). Footrests or side panels are unsuitable for this purpose because they could come loose or break and therefore cause injuries.



Fig. 1: Parts and areas where the wheelchair may be carried

Use of public roads



The wheelchair is designed for indoor and outdoor use.

When using the wheelchair in road traffic, the applicable road traffic regulations must be observed. Do not cover the reflectors attached to the rear of the frame and replace the reflectors attached in the spokes if lost.



Fig. 2 :Reflectors on rear frame

Modifications to the wheelchair



It is not permitted for the user to make any constructional modifications to the wheelchair. Any such changes may endanger safety and possibly impair the service life.

Repairs and maintenance work

 Repairs and maintenance work must only be carried out by specially trained persons. Improperly performed work may impair the safety and durability of the medical device.

Obligation to report serious incidents

 Any serious incident occurring in relation to the device must be reported to the manufacturer and the competent authority of the Member State in which the user and/or patient is established.

Service life

 If all safety, care and maintenance instructions are observed, the expected service life is 5 years when used as intended. The wheelchair can be used beyond this period if it is in a safe condition.

9 PUTTING THE WHEELCHAIR INTO OPERATION

9.1 Unfolding

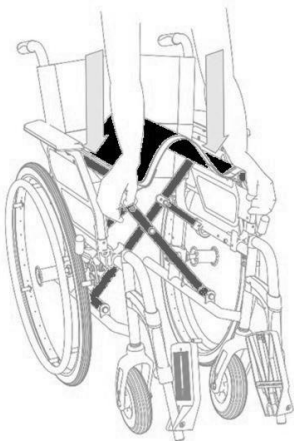

Fig. 3: Unfolding the wheelchair

With the wheelchair folded up, simultaneously press down the right and left seat bars with the palm of your hands. This causes the cross strut to unfold. The mechanism audibly engages.

After unfolding, test whether the mechanism is engaged. Only then sit should you sit in the wheelchair.

9.2 Inserting the footrests



Fig. 4: Inserting the leg supports

Insert the footrests into the mounting in the frame from above. Please note that the right and left footrests are constructed differently. The rests must be mounted so that the footrest always faces the centre of the wheelchair. Now align the footrests so that the feet can be placed comfortably on the rests. When correctly aligned, the supports will audibly click into place.

9.3 Adjusting the lower leg length



Fig. 5: Adjusting the lower leg length

The footrest can be adjusted in height and thereby adapted to your lower leg length.

To adjust the height of the footrest, loosen the hexagon socket set screw on the back of the footrest (see figure).

Then move the lower footrest tube in the guide until you have reached the desired position. Finally, tighten the hexagon socket set screw again.



The length is correct when the foot rests comfortably on the rests while seated and the lower legs have good contact with the seat surface without the weight of the leg obstructing the blood supply to the foot. If necessary, readjust this setting after a few hours of use.

9.4 Adjusting the brakes



Before putting the wheelchair into operation, make sure that the brakes are correctly adjusted. The brakes should

be adjusted by trained personnel. The instructions for adjusting the brakes can be found in 10.4.

10 ADDITIONAL SETTING OPTIONS

To set up your wheelchair optimally to your needs, you will need a set of Allen keys and ring spanners. With a little manual skill, you can adjust the settings yourself.

i Please contact your specialist dealer if you have any questions. Risk of jamming! Pay attention to your fingers when making adjustments.

10.1 Assembling and disassembling the rear wheels



Fig. 6: Disassembling the rear wheel

The rear wheels can be removed, e.g. for transportation.

To do this, push the quick-release button on the quick-release axle as far as it will go (see figure).

The rear wheel can now be removed by pulling it outwards. To re-assemble, place the rear wheel on the quick-release axle until the quick-release button engages automatically.



Before setting off again, make sure that the wheel is fully engaged.

10.2 Adjusting the height of the rear wheels

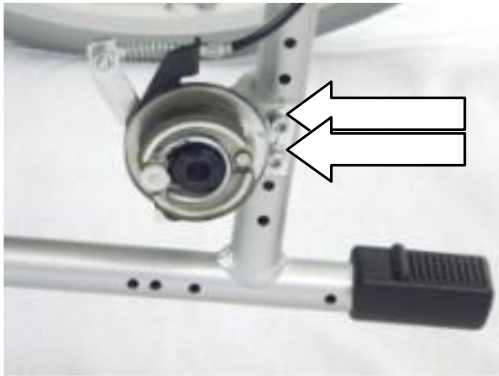

Before you can adjust the height of the rear wheels, you will need to disassemble them (see 10.1). To adjust the height, loosen the screw on the corresponding wheel mount. Then move the wheel mount to the desired hole position. Finally, tighten the screws again.

Fig. 7: Adjusting the height of the rear wheel

Repeat the process on the other rear wheel.



If the drive wheel height is adjusted, the brakes will need to be readjusted (see 10.4).



The correct seat position depends on the physiological needs of the wheelchair user. After completing the adjustment work, make sure that all screws are tightened and that the height adjustment has been performed equally on both sides. Be aware that a higher seat setting reduces the tipping stability.

Make sure that the front wheels and rear wheels are in the same hole position.

10.3 Adjusting the height of the front wheels



Fig. 8: Adjusting the height of the front wheel

To adjust the height, loosen the screw on the corresponding wheel mount. Then move the wheel mount to the desired hole position. Then tighten the screws again. Repeat the process on the other wheel. Finally, tighten the screws again.



After completing the adjustment work, make sure that all screws are tightened and that the height adjustment has been performed equally on both sides.



Please note that the wheelchair must be balanced when the adjustments have been completed.

Changing the height of the front wheels can change the angle of the steering wheel axis. However, this should always be 90° to the horizontal and must be adjusted if necessary. To do this, loosen the two screws on the front wheel axle bracket and adjust the bracket to an angle of 90°. To do this, the bracket can be rotated slightly (when the screws are loose). Replace the nuts with new safety nuts. Replace the screw lock. Tighten the screws again.

10.4 Adjusting the knee lever brakes



Fig. 9: Adjusting the brakes

The wheelchair has a knee lever brake. The distance between the brake bolt and the tyre is adjusted such that the brake can be locked with a force of 60 N (6kg).

To adjust the distance, carefully loosen the two hexagon socket screws at the bottom of the brake bracket (see Fig. 10).

Then slide the brake system on the frame tube into the correct position. The distance between the centre of the brake pad and the tyre (see Fig. 11) should be approx. 2-3 cm depending on the height setting, and should cause the tyre to be slightly pressed in on braking (see Fig. 12). The force used to apply the brake must not exceed 60N.

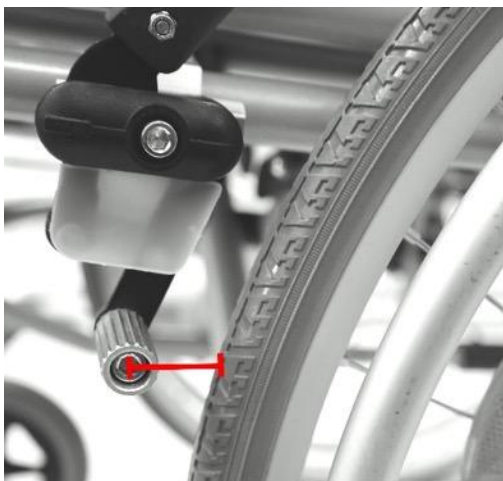



Fig. 11: Brake adjustment distance



Fig. 12: Parking brake applied

 Finally, tighten both hexagon socket screws again. The brakes must only be adjusted by persons with the appropriate expertise. Always remember that incorrectly adjusted brakes can have life-threatening consequences. Make sure that the brake shoe fully engages when the lever is operated and does not spring back.



A faulty brake, especially one that is set too tightly, can reduce the service life of the wheelchair.

10.5 Adjusting the drum brake (depending on model)



Fig. 13: Drum brake adjusting screw

Depending on the model, your wheelchair may have a drum brake, which can be adjusted using the cable clamping screw and the adjusting nut on the brake cable (see Fig. 13). The drum brake is correctly adjusted when the brake lever on the push handle is engaged at level two and when the wheelchair is stationary on even ground and no longer rolls. Please note

that each drum brake only acts on one drive wheel.



The brake setting should only be changed if the brake force is insufficient. Furthermore, such an adjustment must only be performed by appropriately qualified persons.



The brakes should be checked before each use of the wheelchair in order to ensure that natural signs of wear and any decrease in braking efficiency are identified in good time.



If the braking efficiency decreases, the wheelchair must no longer be used!

10.6 Swinging away and disassembling the footrests



The footrests are removable. To do this, pull the lock on the footrest upwards. After unlocking the lock, you can swing the footrest sideways and then upwards out of the guide tubes (see Fig. 14).

Fig. 14: Disassembling the footrests

To insert, follow the above steps in the reverse order. Before using the wheelchair again, make sure that the footrests are correctly mounted.

 The footrests are designed exclusively for resting the feet when sitting in the wheelchair. Never stand on either one or both footrests. Incorrect loading of the footrests could cause damage to the wheelchair and poses a risk of injury.

10.7 Foot board (fold-up)

The foot plates can be connected with a connector to form a foot board.

- When replacing the screws, the screw lock must also be replaced. Firstly, remove both footrests.
- Then remove the fastening screw on the foot plate (step 1).
- Replace the dismantled nuts with new safety nuts and tighten the screws.
- Now push the wedge out sideways (step 2).
- The connector can now be screwed onto the underside of the foot plates.
- Adjust the width of the foot board by loosening the adjusting screws and sliding the foot board apart until it snaps easily into the bracket. Then tighten the screws again.

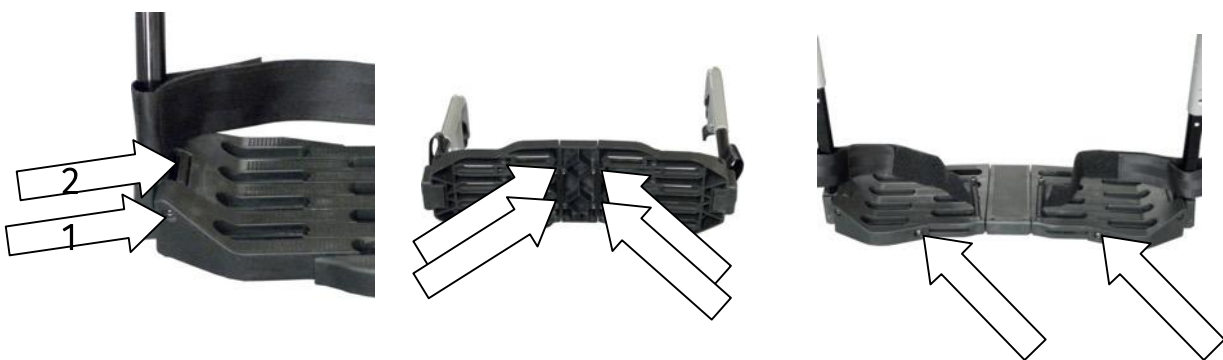

10.8 Folding up the side panels



Fig. 15: Folding up the side panels

The armrest can be folded up towards the back of the wheelchair.

To do this, press the locking lever at the front and at the same time swing the side panel away to the rear (see Fig. 15).

On the outside of the side panel, there is a knob that can be used to adjust the height of the armrests.

11 USING THE WHEELCHAIR

Your wheelchair is designed for it to be easy to get in and out. To make it easier for you to get in, you can swing away the leg supports and fold up the armrests.

11.1 Getting into the wheelchair from the side



Place the wheelchair sideways against a stable wall so that it is even more effectively protected against rolling away.

Bring the side of the wheelchair as close as possible to the seat you are currently sitting in.

Secure the wheelchair against unintentional rolling away by operating the brake levers on the left and right side of the wheelchair.

If you want to transfer from another wheelchair, apply the parking brakes on this wheelchair too in order to secure it against rolling away.

Swing the wheelchair armrest next to your current seat upwards. Then swing both footrests of the wheelchair outwards to the sides.



Now slide sideways onto the new seat. Please make sure that you sit as far back in the seat as possible.

Finally, swing the armrest and the footrests back to the starting position.

To get out of the wheelchair, follow the above steps in the reverse order.



Never stand on either one or both footrests. Incorrect loading of the footrests could cause damage to the wheelchair and poses a risk of injury.

11.2 Getting into the wheelchair from the front



Place the wheelchair backwards against a stable wall so that it is even more effectively protected against rolling away.

Firstly, swing both footrests outwards to the side.

Bring the front of the wheelchair as close as possible to the seat you are currently sitting in.

Secure the wheelchair against unintentional rolling away by operating the brake levers on the left and right side of the wheelchair.

If you want to transfer from another wheelchair, secure this wheelchair by applying the parking brakes.

Now rotate your body to slide onto the seat.

Finally, swing the footrests back into the starting position.



Never stand on either one or both footrests. Incorrect loading of the footrests could cause damage to the wheelchair and poses a risk of injury.

11.3 Seat in the vehicle for transporting disabled people

The wheelchair is tested and approved as a seat in a vehicle for transporting disabled people in accordance with ISO 7176-19:2022.

Only those positions marked with a symbol (Fig. A) are permitted for fastening the force nodes. Other attachment points are not approved by the manufacturer.

A permanently installed car seat is always preferable to a wheelchair.

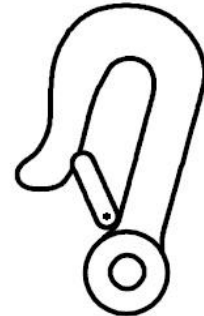

Figure A

Make sure that the person responsible for transportation is familiar with the current regulations for transport in a vehicle for transporting disabled people as well as in the handling of the restraint system.

4-point restraint systems anchored to the vehicle must be used to restrain the wheelchair.

Bags or accessories attached to the wheelchair can be safely stowed in the boot. If it is not possible to remove attachments such as therapy tables, these should be swung away or provided with adequate padding.

When used as a seat in the vehicle for transporting disabled people, the backrest must (if possible) be put into an upright position and the 3-point seat belt worn. Other straps and fixation systems can also be used.



Please note! Products that have been involved in an accident must be replaced without fail and are no longer permitted for the transportation of people.

Positioning the wheelchair



Please note! Never place the wheelchair in front of an active airbag! Deactivate the airbag if necessary.

Position the wheelchair facing forwards (Fig. B).

The straps of the restraint system must be arranged so as to ensure the maximum possible stability of the wheelchair. You can see the angle and dimensions of this by looking at the dashed area in Fig. C.

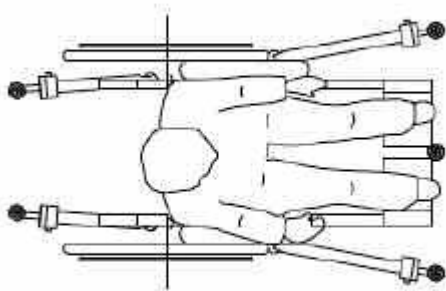

Figure B

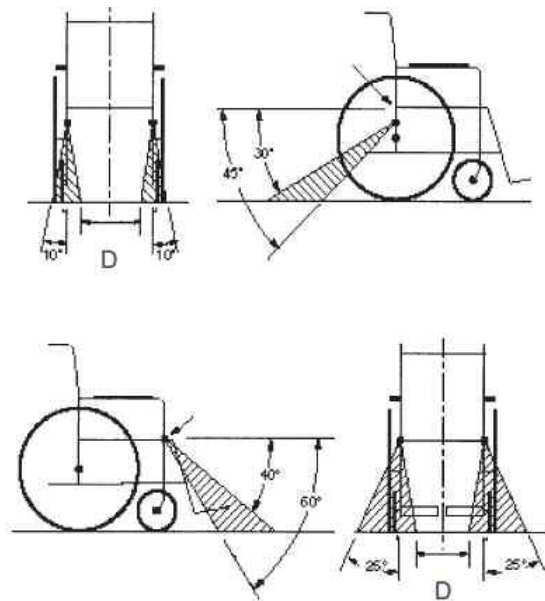

Figure C

Attaching to the vehicle floor

For the attachment to the floor of the vehicle, there is the option of a rail (Fig. D) or the mono system (Fig. E). For the rail, insert the fitting at an angle and then pull it in sideways. The fitting is released by pulling on the snap ring. For the mono system, place the fitting flat on the base disc and pull it over the base disc. Detach the mono fitting by pulling it down from the bottom disc.

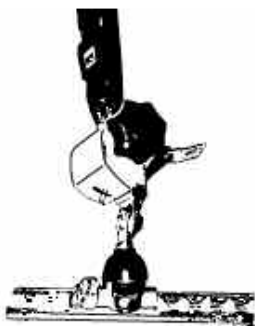

Figure D



Figure E

Attaching to the wheelchair

On the wheelchair, the fastening straps must be attached at the marked points with force node ties (Fig. F) or loop ties (Fig. G).

 Please note! Other places such as attachment parts or foot-rests are not suitable as attachment points!

The straps can be tightened with the handle (Fig. H).

Release the straps via the lever on the handle or using the belt lock (Fig. I).

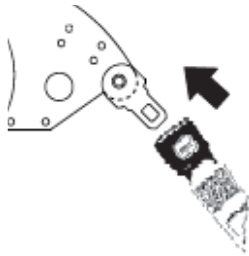

Figure F

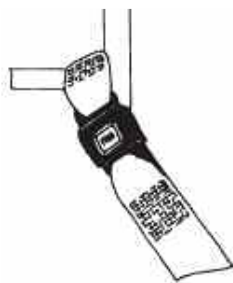

Figure G



Figure H

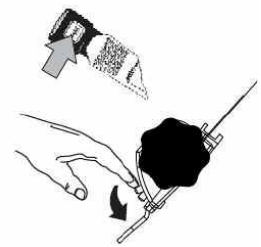

Figure I

Seat belts

The seat belt must be attached to the rear force nodes on both sides, maintaining an angle of 30° to 75° to the horizontal (Fig. J, dashed area). Larger angles are preferable here.

The belt must be positioned low on the pelvis; it should be tight but not so tight that it digs in. The belt must not be twisted when it is put on.

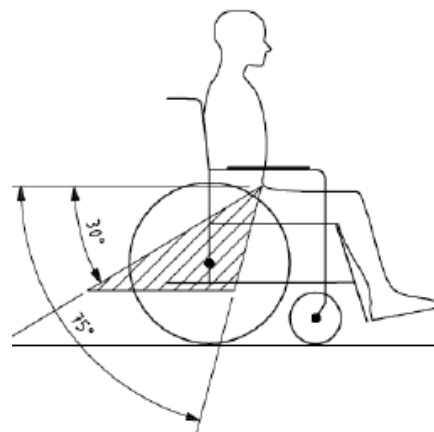

Figure J

Be careful not to place the buckle on the pelvic bone. The clasp must be placed such that it cannot be opened accidentally in the event of an accident.

To close the lock, insert the tongue into the buckle. It audibly clicks into place. The lock opens when you press the large button.

You can adjust the belt to your body measurements by pulling the loose end or sliding the clasp forward.

The shoulder strap is hooked into the lap belt. It must be routed close to the body at the pelvis and chest and over the shoulder.

Belts and straps must not be routed over attachment parts of the wheelchair such as armrests or wheels! (Fig. K & Fig. L)



Figure K



Figure L



Figure M

In order to be able to remove the belts quickly in the event of an accident, a belt knife (Fig. M) should be carried in every vehicle.

12 TRAVELLING IN THE WHEELCHAIR

12.1 General information

Sit in your wheelchair and slide as far back as you can. Both drive wheels are fitted with push rims. Moving forward and braking are performed via the push rims.

 Risk of jamming! Make sure to only grasp the push rims, and do not let your fingers get into the spokes.

Carry out your first handling attempts carefully and on level, manageable terrain. Trips outside the home should only be undertaken with sufficient handling experience. If necessary, have someone accompany you.



When using the wheelchair, be aware of the risk of tipping and slipping. Special care should be taken when braking, starting or turning on uphill or downhill gradients.



Your posture also has an impact on stability. Excessively leaning to the side increases the risk of tipping over.



You can hang shopping bags or a backpack on the frame of the backrest. Please note that this significantly increases the risk of tipping backwards.

Apply both parking brakes before getting in or out of the wheelchair.

12.2 Push handles

The push handles allow another person to push, steer and brake the wheelchair.



Please note that the accompanying person must have sufficient strength to bring the wheelchair to a standstill even in emergency situations.



In addition, the wheelchair can be stopped via the optional drum brakes, which also serve as parking brakes.

12.3 Braking

Your wheelchair is equipped with a tyre brake (knee lever brake) that can be operated by the occupant.



These brakes must only be used as parking brakes, i.e. they must only be applied when the wheelchair is at a standstill, and not to reduce the driving speed.

The parking brakes are not suitable for slowing down when using the wheelchair. The push rims are used for this purpose, by the application of light pressure via the palms of the hands.



Some wheelchair users prefer to wear special wheelchair gloves, especially when first starting out. These gloves make it possible to operate the push rim while accelerating and braking, and are gentle on the palms.

When the wheelchair is stationary, the two parking brakes can be applied. To do this, push both brake levers forward until the brake shoe engages.



Fig. 16: Unbraked condition



Fig. 17: Braked condition

13 DECLARATION OF CONFORMITY

As the manufacturer of the device, Besco Medical Medizin- und Rehaprodukte GmbH declares that the Primus ML 2.0 fully complies with the requirements of the European Medical Device Regulation 2017/745 (MDR).

13.1 Labelling

Each wheelchair is provided with a type plate (see example below). This is located on the cross strut.

Please enter the serial number found there on the warranty section and in the service check book.



14 ACCESSORIES AND ATTACHMENTS

14.1 Tilting aid



Fig. 18: Use of the tilting aid

The wheelchair is equipped with a tilting aid. The tilting aid makes it easier for the accompanying person to tip the wheelchair, e.g. to drive over a step. To do this, press the lever down with your foot. You can use the push handles to help keep your balance.



The tilting aid sticks out to the rear on the right and left of the frame and is fitted with rubber profiles to ensure sufficient grip.

14.2 Anti-tip wheels (optional)



Fig. 19: Fitting the anti-tip supports

The anti-tip wheels can be fitted instead of the tilting aid. These wheels prevent the wheelchair from tipping backwards when the centre of gravity is shifted. The height of the anti-tip wheels can be adjusted. To do this, push in the pin and pull the fixing tube out to the desired position. Make sure that it audibly clicks into place.

14.3 Seat belt (optional)



Check the seat belt for secure fit and correct armrest function.



You can use the tab to adjust the length. The belt should be tight but not pinch.

A seat belt is available as an accessory. The seat belt is attached to the bracket on the armrest. To do this, remove the screw (see figure). Then pull the seat belt through the eyelet and tighten the screw again.



Fig. 20: Fastening the seat belt



Fig. 21: Fastening the seat belt

To fasten the seat belt, simply insert the buckle into the belt lock (see figure). It audibly clicks into place.

To open, simply press the red button.

14.4 Drum brake (depending on model)



Fig.22: Operating the brake

The wheelchair can optionally be equipped with a drum brake that can only be operated by an accompanying person via the brake levers on the push handles.

The drum brake can be used both as a parking brake and a service brake. When used as a service brake, it can be used to gradually slow down the wheelchair.

The locking function is used for parking. To release the brake, press the locking lever and release the brake lever (see figure - arrow). To use the drum brake as a parking brake, operate the locking lever when braking.

15 CARE INSTRUCTIONS

15.1 Cleaning



Always keep the wheelchair clean. This extends the service life and makes it easier to identify any maintenance requirements.

Remove coarse soiling immediately after use.

Frame parts and panelling can be cleaned with a cloth dampened with warm water. A mild household cleaning agent can be used for stubborn soiling. Make sure to clean all surfaces thoroughly. Cleaning agent residues can then be removed with a damp cloth.



Follow the cleaning agent manufacturer's instructions. If necessary, use appropriate protective clothing, such as overalls, safety goggles and gloves.

After cleaning, check to make sure that all dirt and deposits have been completely removed.



Do not use abrasive cleaners, corrosive substances, acids or bleach. Cleaning agents based on chlorine, acetone or benzene must not be used.



Do not use a high-pressure cleaner or a steam cleaner. These can damage the bearings and the material, among other things.





Make sure that no residues of cleaning agents remain on handles and wheels. Cleaning agent residues mean a risk of slipping and make it difficult to handle the wheelchair.

15.2 Disinfection

In principle, your wheelchair can be disinfected. Only use alcohol-based disinfectants for this purpose.

 Alcohol-based disinfectants evaporate completely and leave no residue

 Follow the disinfectant manufacturer's instructions on concentration and exposure times.

 The device should be cleaned before disinfection, as otherwise disinfection will not be successful.

Disinfection can be carried out as spray and wipe disinfection.

Wet your wheelchair evenly with disinfectant. Do not rinse the disinfectant and allow the product to air dry. Then check the product for cleanliness and damage.

 Use a VAH-listed disinfectant

16 STORAGE AND TRANSPORT

16.1 General information

 The wheelchair should only be stored in a clean condition.

 To store the wheelchair, we recommend packing all removable parts individually and then storing them together with the wheelchair in a large cardboard box. This provides your wheelchair with optimal protection against environmental influences.

 If possible, keep the original packaging.

16.2 Storage conditions:

Store your device in a dry place and protect it from sun and heat.

Make sure to store all dismantled parts together in one place (label if necessary) in order to rule out the risk of confusing them with parts from other devices during reassembly.

Do not place any heavy parts on the wheelchair, and do not wedge the wheelchair between other parts.

 To save space when transporting the wheelchair in the car or boot, you can remove the attachments. Stow the wheelchair and parts so that they are secured against slipping. Use straps if necessary.

17 DISPOSAL

 If your wheelchair is no longer in use and is to be disposed of, please contact your specialist dealer.

If you wish to dispose of it yourself, please ask local disposal companies about the disposal regulations in your area.

18 PASSING ON THE WHEELCHAIR

When passing on the wheelchair, please remember to give all the technical documents required for safe use to the new user. The wheelchair must be thoroughly reprocessed according to the cleaning and disinfection instructions. It must then be checked and approved by a specialist in accordance with the maintenance log.

19 TECHNICAL DATA

Dimensions and weights	
Total length with leg supports	990 cm
Seat width	380, 400, 430, 450, 480, 500, 520 mm
Total width	Seat width + 200 mm

Seat height from floor to front edge of seat	Adjustable from approx. 430 - 530 (mm)
Backrest angle	5°
Backrest height	400 cm
Seat angle	4 °
Seat depth	420 cm
Distance between armrest and seat	230 cm
Front attachment of the armrest, measured from the backrest	390 cm
Push rim diameter	530 cm
Length (folded)	830 cm
Height (folded)	840 - 960 mm, depending on seat height
User weight	130 kg
Unladen weight incl. side panel, footrests and drive wheels	15.8 /16.1 /16.7 /17.0 /17.5 /18.1 /18.7 (kg)
Side panel weight	1.0 kg
Footrest weight	1.1 kg
Drive wheel weight	1.8 kg
Turning radius	450 cm
Tyres	
Drive wheels	24" x 1⅜" (puncture-proof)
Steering wheels	7" x 1¾" (puncture-proof)
Material	
Frame	Aluminium, powder-coated
Cross strut	Steel, powder-coated

Seat and backrest upholstery	Nylon, black
Arm pads	Polyurethane, black
Side panels	Plastic, black
Footrests	Plastic, black
Handles	Plastic
Brakes	Aluminium brakes
Tyres	Polyurethane
Flammability	Seat and back cover flame-retardant (California Technical Bulletin 117-2013)
Storage conditions	Protect from direct sunlight and heat Protect from moisture

20 INSPECTION AND MAINTENANCE



Watch out for risks of injury from mechanical parts during maintenance and care. If necessary, the use of work gloves is advisable.



The user can carry out inspections himself. The appropriate expertise is required for adjustment work and repairs. Repairs, maintenance work and attachments that do not comply with the manufacturer's specifications will invalidate the warranty.



The service life of the wheelchair depends on the type of use, storage, regular inspections, service and care.

20.1 Regular maintenance



The maintenance work serves to ensure the proper condition of your wheelchair over the period of use. We recommend the following work:

Inspection	Before setting off
Check tyres for dirt and damage	X
Check the screws, levers and adjusting wheels	X
Check the brakes and adjust if necessary	X
Check the folding mechanism for correct functioning	X
Check all screwed and riveted connections for integrity	X
Check the wheelchair for cleanliness, cracks, damage to load-bearing parts etc.	X
Clean the reflectors.	X

How to check the brakes: When the brake is applied, it should not be possible to push the wheelchair away (the wheels should lock). When the brake is released, the wheelchair should be easy to drive without grinding noises and with good directional stability.



If you notice any unusual braking behaviour, inform your specialist dealer immediately and remove the wheelchair from circulation.

Inspection	Every 8 weeks
Check the armrests or splash guard and adjust if necessary	X
Check the foot supports and heel strap and adjust if necessary	X
Check the brake lever and adjust if necessary	X
Check the wheel axles and adjust if necessary	X

Inspection	Annually or for each new user
General inspection (see service booklet)	X
Disinfection	X
Clean the steering wheels, and bearings if necessary	X
Check the wheel axles and adjust if necessary	X

In order to maintain its safety and functioning, your wheelchair must be checked and serviced regularly. Repair and assembly work must be carried out by authorised persons and documented in the service booklet for your device. The maintenance schedule in the enclosed service booklet may only be signed if all points in the service schedule have been checked.

To make it easier for you to carry out this work regularly, we have printed the maintenance schedule in a separate service booklet.

Only authorised Besco Medical spare parts may be used.

If you have any questions regarding the maintenance schedule or the service booklet, please do not hesitate to contact Besco Medical Customer Service.

21 WARRANTY AND GUARANTEE

This Besco Medical product is covered by a 2-year limited warranty. The warranty for the frame or the crosspiece of the product is extended to 5 years with regular inspection and maintenance.

Our warranty covers all defects in this product that can be proven to be due to defects in materials or workmanship. In any case, the warranty section must be completed in full and a copy of the service documentation must be submitted to us.

Damage caused by use outside the intended purpose and the provisions of this instruction manual is expressly excluded from warranty and product liability claims. The same applies to modifications to the wheelchair and the exchange or replacement of original components with parts from other manufacturers or parts copied from the original, as well as to the use of unsuitable care products, lubricating oils or greases. The warranty is also excluded if maintenance work has not been carried out or has not been carried out properly, as well as in the case of changes and additions to this product without our written consent.

Warranty information for the aid:	
Model	
Serial number	Dealer's stamp
Date of commissioning	

NOTIZEN

A digital version of this instruction manual can be found at:

www.bescomedical.de/downloads



Besco Medical Medizin- und Rehaprodukte GmbH

Am Autobahnzubringer 8

76709 Kronau, Germany

Phone: +49(0)7253 - 97596-0

Fax: +49(0)7253 - 97596-50

Mail: info@bescomedical.de

Website: www.bescomedical.de

